

# Sanitary RTDs and Temperature Transmitters

## Introduction

Anderson-Negele's electronic temperature sensors combine our industry proven, all stainless steel construction with modular components. Interchangeable RTD elements, wiring heads, transmitter modules and digital displays can be individually selected. Components can be factory or field assembled in the optimum configuration for any application. To further facilitate adaptability, our RTD's are offered with the widest selection of sanitary clamp and thermowell fittings; and with sealed cable, quick disconnect, or wiring heads options.

Our temperature transmitters are available in analog and HART "SMART" versions. These modules can be factory or field installed in any wiring head or panel mounted remotely from the RTD element allowing for greater flexibility. New Dual Output options provide two signals in virtually any combinations. Ordering information, technical specifications and dimensional drawings are included herein, or for more information please visit our Web Site at [www.anderson-negele.com](http://www.anderson-negele.com), or contact your local Authorized Anderson-Negele Distributor.

## Features

- Modular components provide maximum configuration flexibility
- Unique element-to-housing design eliminates exposed threads, lowers profile
- All stainless steel construction with O-ring seals for maximum corrosion and moisture protection
- NIST traceable with certifications
- Custom lengths (up to 6") available at no extra charge
- Dual Output Options
- Quick Disconnect Options



**Sanitary RTD's**

Anderson-Negele SW-Series RTD sensors are 100 ohm, 3-wire, DIN standard elements designed for direct immersion in sanitary applications or in any of a wide variety of thermowells. Sensors are available in single or dual element configurations. Single element styles may be specified with factory sealed, shielded cables up to 200 feet in length, in our unique modular design, or with our new water-tight quick disconnect. The modular elements can be mated with a standard wiring head for analog or "SMART" transmitter applications, with or without an integral display. Also available is a mini wiring head for stand-alone RTD applications, optionally available with a new mini (4-20mA) transmitter module. All dual element sensors are supplied in the modular configuration, now available with dual output wiring heads as well.

All sensors feature completely sealed internals for maximum moisture and vibration resistance. They provide the fastest possible response characteristics due to our unique method of internal element attachment which eliminates all air and non-metallic materials between the element and the process material being monitored.

These sensors are constructed entirely of 316L grade stainless steel and all product contact surfaces are electropolished to an  $R_a$  max. of 8 micro-inches (0.2 microns), except well fitting. All elements are provided with a permanently engraved stainless steel tag and a certificate of calibration and conformance.

- All stainless steel with no exposed threads
- Compact, low in profile
- Field serviceable - replaceable elements
- Multiple wiring options

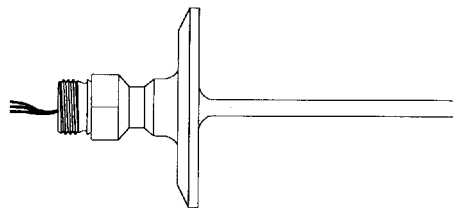

**Specifications**

**RTD ELEMENTS**

<p><b>General:</b> 100 ohm, 3-wire sensors* which conform to DIN standards. Single element standard; dual element optional</p> <p><b>Coefficient:</b> .00385 ohms/ohm/Deg. C</p> <p><b>Accuracy:</b> Conforms to ASTM E1137-B and IEC-751B; 0.10% (0.26°C) at ice point 0.18% (0.66°C) at 100°C 0.21% (1.0°C) at 180°C</p> <p><b>Probe Diameters:</b> 1/4" standard for sanitary clamp styles (1"-4") single or dual element. 5/32" standard for direct mount, clamp styles (1/2" - 3/4") clamp and "mini wells" single element only for mini styles Other diameters available for thermowell installation</p> <p><b>Response:</b> 2.5 to 3 seconds for 63% step change</p>	<p><b>Span:</b> 400°F (221°C) maximum</p> <p><b>Low End:</b> -50°F (-45°C) minimum</p> <p><b>High End:</b> 350°F (180°C) maximum</p> <p><b>Material:</b> 316 "L" Stainless Steel wettable parts</p> <p><b>Surface Finish:</b> 8 micro-inch <math>R_a</math> electropolished 32 micro-inch <math>R_a</math> (thermowell fittings)</p> <p><b>Fitting Styles:</b> All standard sanitary clamp styles, including fractional clamps and mini thermowell styles; Refer to ordering matrix for details</p> <p><b>Standards:</b> Designed and manufactured to sound engineering practices in accordance with Article 3.3 of the PED 97/23/EC. CSA B51-03 CRN# CSA0F9754.5C</p> <p><b>Warranty:</b> 1 year</p> <p>* RTD's with quick disconnect are configured for 4-wire connection to minimize output errors from connection resistance.</p>
---	---

**Wiring Heads**

<p><b>General:</b> The wiring heads are designed to accept any type of RTD element, but offers the cleanest package when coupled with Anderson "no exposed thread" RTD's, which provide an O-ring seal against the housing.</p> <p><b>Material:</b> 304 Stainless Steel</p> <p><b>Surface Finish:</b> 32 micro-inch <math>R_a</math> max.</p> <p><b>Dimensions:</b> Standard: 3.15" O.D. X 2.75" L Mini head: 2.0" O.D. X 2.3" L Dual head: 3.15" O.D X 4.27" L</p>	<p><b>Penetrations:</b> (2) at 1/2" - 14 NPT female; (1) centered in bottom plate; (1) in side beneath cap rim.</p> <p><b>Cable Connections:</b> Standard NEMA 4X "Hubbell" style cable "grip", or Optional Quick Disconnect with Field Wireable Connector</p> <p><b>Ratings:</b> NEMA 4X; IP66</p> <p><b>Warranty:</b> 1 year</p>
---	--

### Temperature Transmitters

Temperature transmitters are available in three (3) styles to provide maximum application flexibility. Analog (4-20mA) modules are available in a standard size for mounting in our standard wiring head, or for remote mounting in a control panel. A new "mini" transmitter comes pre-mounted in our "mini" head, providing the world's smallest, all stainless steel transmitter/sensor assembly. "SMART" HART modules are also available for use with our standard wiring head. Any standard head with a transmitter module is also available with a loop-powered display as an option, providing local indication in degrees (F or C), milliamps, or percent output. The standard wiring head can be oriented vertically or horizontally to simplify wiring and optimize viewing angle. Any of the above may be specified in single (standard) or dual (any combination) outputs.

The result is a competitively priced transmitter which is:

- Modular - field replaceable/upgradeable components.
- All stainless steel with no exposed threads
- Compact, low in profile

All prewired element/transmitter assemblies are factory calibrated and shipped with NIST traceable certifications.

### Specifications

#### ANALOG TRANSMITTER MODULE (STANDARD OR "MINI")

Input:	3-wire, 100 ohm, DIN standard curve (.00385 ohms/ohm/°C)	Isolation:	Non-isolated
Output:	2-wire, 4-20 mA analog	Burn-Out:	Upscale (factory standard) Downscale (consult factory)
Power Supply:	12 to 40 Volts d.c. loop power required	Zero Adjustment:	"Pot" adjustable to ±15°C (±25°F) typical
Power Supply Effect:	Less than 0.0125% of full scale output/volt	Span Adjustment:	"Pot" adjustable over a 15°C (25°F) range minimum
Accuracy:	0.1% of calibrated span, linearized	<b>AGENCY APPROVALS</b>	
Min/Max. Span:	50°C or F / 180°C, 300°F	Hazardous Locations:	(Mini Only) Meets UL requirements for Class 1, Div. 1&2; Groups A-D for intrinsically safe apparatus when installed with barrier as required in control drawing provided in manual.
Min/Max. Low End:	0°C or F / 100°C or F		
Min/Max. High End:	50°C or F / 180°C, 350°F		
Wiring Connections:	Screw terminals with #3 screws. (removable screw terminal connectors for Mini)		

#### SMART (HART) Transmitter Module

Input:	3-wire, 100 ohm, DIN standard curve (.00385 ohms/ohm/°C)	<b>AGENCY APPROVALS</b>	
Output:	4-20 mA, linear with temperature; Digital output signal superimposed on 4-20mA signal; "HART" compliant	Electromagnetic Compatibility (EMC):	CE Compliant (for optional LCD only, display accuracy de-rated up to 2% in 150 - 180 MHz and 230 - 350MHz, 10V/M RF Field).
Isolation:	Input/Output isolated to 500V rms (707V p-p)	Hazardous Locations:	Meets UL requirements for Class 1, Div. 1&2; Groups A-D for intrinsically safe apparatus when installed with barrier as required in control drawing provided
Accuracy:	± 0.1% of upper range limit (URL); includes non-linearity, and hysteresis	Ambient Limits:	-18 to 50°C
Stability:	0.1°C per 6 months	Ambient Effects:	±0.13°C per 28°C temperature change
Min/Max. Span:	6:1 turndown (38°C) / 230°C	Storage Temperature:	-40 to 65°C
Maximum Range:	-50 to 180°C	Humidity:	0-100% RH
Power Required:	14-40 VDC external loop power (unregulated)	Vibration Effects:	Withstands 2g at 10-60 Hz
Power Supply Effect:	Less than 0.005% of span per Volt	Failure Mode:	Field selectable, High or Low
Max. Loop Resistance:	(Supply Voltage - 14) X 40 = Ohms	Warranty:	Two Years

#### Loop Powered Display Module

Loop Powered Display Module		Digits:	3-1/2 digits
General:	The display module provides a local display of temperature (°F or °C) or output value (milliamps or percent). It mounts in the cap of our standard wiring head and is powered by the loop power supply. It is designed to be easily added to any unit in the field or can be specified initially with any unit or transmitter.	Digit Size:	.5" High
		Type:	LCD
		Mounting:	Integral to cap; field replaceable/ upgradeable
		Units of Display:	4-20mA; 0-100%; Degrees C; Degrees F (0-199.9°F max) factory set, or 0-300 F
		Accuracy:	±0.2% of scale
		Loop Resistance:	Adds less than 250 ohms

Order Information

Pharmaceutical RTD's



- WIRING STYLE**
- 1 Sealed Cable w/Strain Relief
  - 2 Sealed Cable w/male 1/2" NPT & Strain Relief
  - 5 6" leads for use with wiring head (see CT matrix)
  - 7 Quick Disconnect (see Quick Disconnect Connection/Cable)

- ELEMENT TYPE**
- 1 100 ohm Single (DIN std.)
  - 2 100 ohm Dual (DIN std.) (available w/wiring style #5 only)

<b>FITTING</b>		<b>PROBE LENGTH/(STANDARD DIAMETER) <sup>2</sup></b>	
001-011	1/2" Tri-Clamp <sup>1,5</sup>	1-1/8"	(.156"; Single Element Only)
002-013	3/4" Tri-Clamp <sup>1,5</sup>	1-1/4"	(.156" Single; .250" Dual)
002-037	3/4" Tri-Clamp <sup>1,5</sup>	2-3/4"	(.156" Single; .250" Dual)
004-037	1-1/2" Tri-Clamp <sup>1,5</sup>	2-3/4"	(.250" Single or Dual)
005-049	2" Tri-Clamp <sup>1,5</sup>	3-1/2"	(.250" Single or Dual)
006-049	2-1/2" Tri-Clamp <sup>1,5</sup>	3-1/2"	(.250" Single or Dual)
007-053	3" Tri-Clamp <sup>1,5</sup>	3-3/4"	(.250" Single or Dual)
008-065	4" Tri-Clamp <sup>1,5</sup>	4-1/2"	(.250" Single or Dual)
010-031	1-1/2" APC "K" <sup>3</sup>	2-3/8"	(.250" Single or Dual)
011-730	2" APC "K" <sup>3</sup>	2-25/32"	(.250" Single or Dual)
016-031	1-1/2" Cherry-Burrell "I"	2-3/8"	(.250" Single or Dual)
017-730	2" Cherry-Burrell "I"	2-25/32"	(.250" Single or Dual)
027-044	1-1/2" G&H "H" Line (male)	3-3/16"	(.250" Single or Dual)
028-056	2" G&H "H" Line (male)	3-15/16"	(.250" Single or Dual)
032-033	1-1/2" Cherry "Q" <sup>3</sup>	2-1/2"	(.250" Single or Dual)
033-049	2" Cherry "Q" <sup>3</sup>	3-1/2"	(.250" Single or Dual)
062-139	Projectile Well (41247) <sup>4</sup>	9-1/8"	(Tapered to Fit Well)
064-187	Projectile Well (41279) <sup>3,4</sup>	12-1/8"	(Tapered to Fit Well)
083-137	Bi-Metal Well - 1/4" NPT <sup>4</sup>	9"	(.250" Single or Dual)
084-089	Bi-metal Well - 1/2" NPT <sup>4</sup>	6"	(.250" Single or Dual)
084-137	Bi-Metal Well - 1/2" NPT <sup>4</sup>	9"	(.250" Single or Dual)
088-000	Anderson Flush Mt. (short)		
089-000	Anderson Flush Mt. (long) <sup>5</sup>		
098-000	Taylor Flush Mount <sup>3,5</sup>		
100-049	Industrial well(41070) <sup>5</sup>	3-1/2"	
101-091	Industrial well(41074) <sup>5</sup>	6-1/8"	
174-089	Spring Loaded 1/4" Dia.-1/2" NPT <sup>4</sup>	6"	
174-137	Spring Loaded 1/4" Dia.-1/2" NPT <sup>4</sup>	9"	

- 0 FIXED CHARACTER**
- CABLE TYPE**
- 0 No Cable Required (Std. w/wiring style #5, available for wiring style #7)
  - 1 Multiple conductor PVC (Std. w/wiring style #1 or #2, available for wiring style #7)
  - 3 3 conductor (red, red, white), White Teflon<sup>®</sup> Jacket (FEP) (available with wiring style #1 or #2 only)

- CONNECTION/CABLE**
- 00 No Cable (wiring style #5 above)
  - 01 5' (Standard with wiring style #2)
  - 05 25' (Standard with wiring style #1)
  - 10 50'
  - 15 75'
  - 20 100'
  - 21 125'
  - 22 150'
  - 23 175'
  - 24 200'

- QUICK DISCONNECT OPTIONS**
- A0 Quick Disconnect Receptacle(QDR) w/no cable
  - A1 QDR & Field Wireable Connector(FWC) w/ no cable
  - A2 QDR w/25 ft 5-Conductor Molded Cordset
  - A3 QDR w/50 ft 5-Conductor Molded Cordset
  - A5 QDR w/100 ft 5-Conductor Molded Cordset

- <sup>1</sup> Recommended for "short outlet "T" applications.
- <sup>2</sup> Custom lengths (up to 6") available at no extra charge, but are non-cancellable/non-returnable for credit.
- <sup>3</sup> Sensors with these fittings are non-cancellable/non-returnable for credit.
- <sup>4</sup> Meets 3-A when used with a 3-A compliant well
- <sup>5</sup> Not 3-A compliant

**ACCESSORIES**  
**Anderson Weld-In Shells for Flush Mount Fittings**  
 71060A0003 Insulated Vessel (089 fitting) - Standard Flange - 316L  
 71060A0004 Uninsulated Vessel (088 fitting) - Standard Flange - 316L

Order Information

Modular Wiring Heads for RTD's and Transmitters

	<p><b>PRODUCT CODE</b> _____</p> <p><b>STYLE</b> _____</p> <p>1 Standard                  2 Standard (with health authority seal provision)                  3 Mini (for RTD and analog transmitter)                  4 Mini (with health authority seal provision)                  7 Standard, Dual Output                  8 Standard, Dual Output (with health authority seal provision)</p> <p><b>MODULE*</b> _____</p> <p><u>Single Output Options</u>                  0 No Module                  1 Single RTD                  2 Dual RTD                  3 4-20mA Analog transmitter (head style 1 or 2 only)                  4 "SMART" Module with 4-20 mA and HART (head style 1 or 2 only)                  5 4-20mA Mini transmitter (head style 3 or 4 only)                  6 4-20mA Mini transmitter (head style 3 or 4 only) (for use with probe lengths of 1.25" or less)</p> <p><u>Dual Output Options</u>                  A Dual 4-20mA Temperature Transmitter                  B Dual Smart with 4-20mA with "HART"                  C 4-20mA Temperature Transmitter &amp; RTD                  D Smart 4-20mA with "HART" &amp; RTD                  E 4-20mA Temp. Transmitter &amp; Smart 4-20mA with "HART" Transmitter</p> <p><b>OUTPUT RANGE</b> _____</p> <p>000 None (RTD only)                  069 0-60 (C only)                  071 0-100 (F or C)                  073 0-150 (F or C)                  075 0-200 (F only)                  076 0-250 (F only)                  077 0-300 (F only)                  119 30-230 (F only)**                  132 50-250 (F only)**                  160 100-300 (F only)                  255 0-180 (C only)                  999 Programmable (Module Style 4, B, and D only)</p> <p><b>ENGINEERING UNITS</b> _____</p> <p>0 None - RTD Only (Module 1 &amp; 2 above)                  F Fahrenheit                  C Celsius                  P Programmable (Module Style 4, B, and D only)</p> <p><b>DISPLAY/UNITS</b> _____ (Module style 3 &amp; 4 only)</p> <p>00 None                  01 4-20mA                  02 0-100%                  03 °F (same range as output)                  04 °C (same range as output)</p>	<p><b>CONNECTION / CABLE</b>                  (Includes water tight cord grip)                  00 No cable (Std.)                  05 25ft                  10 50ft                  15 75ft                  20 100ft</p> <p>(Quick Disconnect Options)**†                  A0 QDR only                  A1 QDR &amp; Field Wireable Connector (FWC)                  A2 QDR / FWC w/ 25ft                  A3 QDR / FWC w/ 50ft                  A5 QDR / FWC w/ 100ft</p> <p><b>1</b> <b>FIXED CHARACTER</b></p> <p><b>PRE-WIRED ELEMENT</b>                  (refer to figure 1 for orientation)                  0 None                  1 Vertical Orientation (option "A")                  2 Horizontal Orientation (option "B")</p> <p>* To order only the output module, consult our Customer Service Department.</p> <p>"SMART" Module Part Number: 5610100003</p> <p>** This range available with display options 00, 01, 02 only.</p> <p>*** Not available with output range 000.</p> <p>† Not available with Dual Output</p>

Figure 1 - Probe Orientation

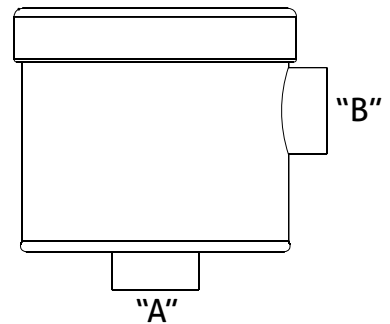

Dimensional Drawings

Modular Wiring Heads

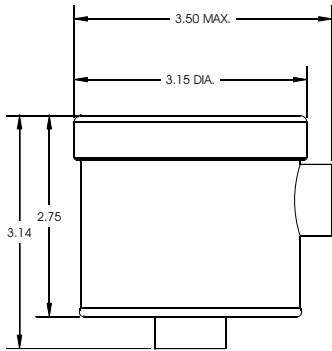

STANDARD WIRING HEAD

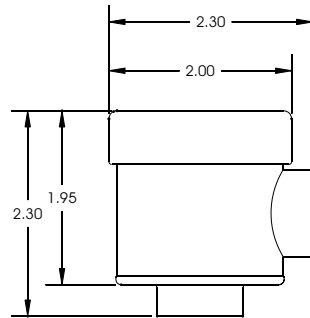

"MINI" WIRING HEAD

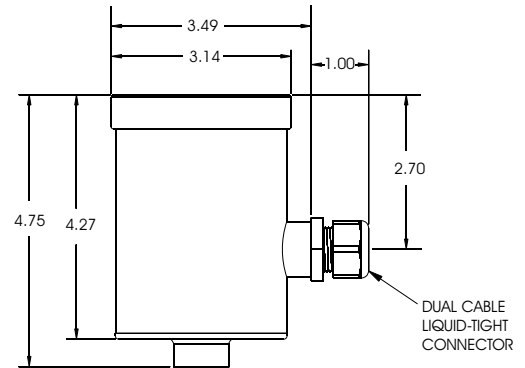

DUAL OUTPUT WIRING HEAD

RTD Fitting Styles and Sizes

1/2" & 3/4" TRI-CLAMP® STYLES

DESCRIPTION	"A" DIM.	"B" DIM.
1/2" TRI-CLAMP®	1-1/8"	5/32" DIA.
3/4" TRI-CLAMP®	2-3/4"	5/32" DIA.
3/4" TRI-CLAMP®	2-3/4"	1/4" DIA.*
3/4" TRI-CLAMP®	1-1/4"	5/32" DIA.
3/4" TRI-CLAMP®	1-1/4"	1/4" DIA.*

\* Dual element

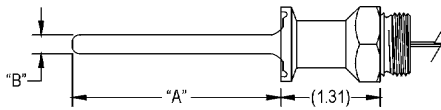

1-1/2" - 4" TRI-CLAMP® STYLE

DESCRIPTION	"A" DIM.	"B" DIM.
1-1/2" TRI-CLAMP®	2-3/4"	1/4" DIA.
2" TRI-CLAMP®	3-1/2"	1/4" DIA.
2-1/2" TRI-CLAMP®	3-1/2"	1/4" DIA.
3" TRI-CLAMP®	3-3/4"	1/4" DIA.
4" TRI-CLAMP®	4-1/2"	1/4" DIA.

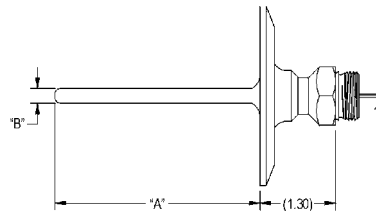

WELL STYLES

DESCRIPTION	"A" DIM.
41247 WELL	9-1/8"
41279 WELL	12-1/8"

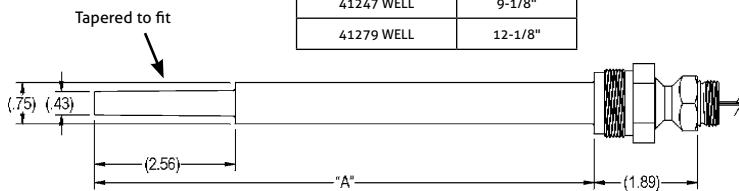

SPRING LOADED STYLES

DESCRIPTION	"A" DIM.	"B" DIM.
1/2" NPT	6"	1/4" DIA.
1/2" NPT	9"	1/4" DIA.

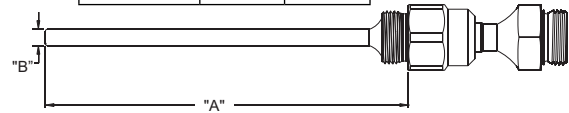

AIC FLUSH MOUNT

DESCRIPTION	"A" DIM.
LONG	6.50
SHORT	2.19

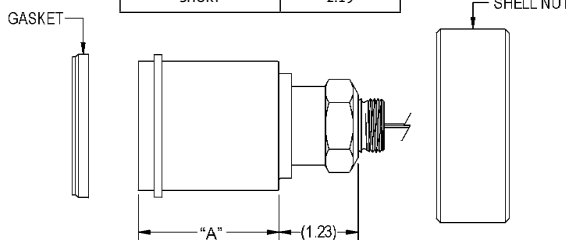

TAYLOR FLUSH MOUNT

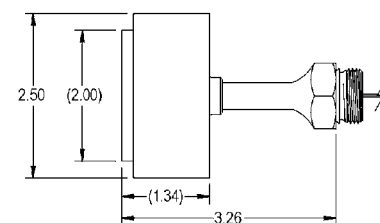

Special "A" dimension available upon request.

## Dimensional Drawings

## RTD Styles

## QDR RTD

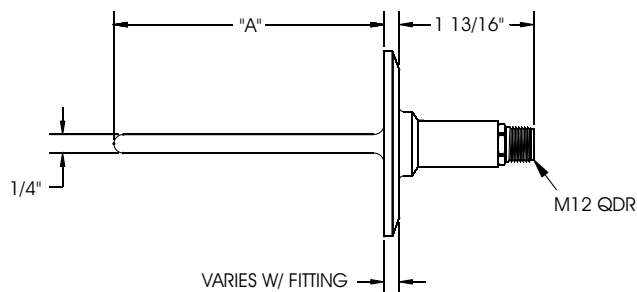

## Sealed Cable RTD

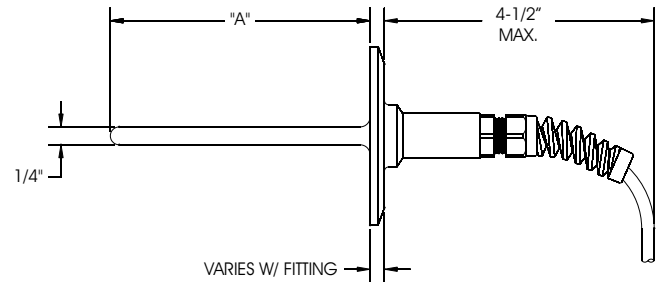

## Ordering Examples

1. Pharmaceutical Series RTD, single element, 50' sealed cable with strain relief, 1.5" Tri-Clamp® fitting.  
Model #: SW110040370110
2. Pharmaceutical Series RTD, dual element, with wiring head, 2" Tri-Clamp® fitting.  
Model #'s: SW520050490000 (RTD)  
CT320000001100 (wiring head)
3. Analog (4-20mA) temperature transmitter, 0-150°C range, 0-100% display, with pre-wired RTD, Pharmaceutical Series with thermowell fitting for 6" insertion, 1/4" diameter, 1/2" NPT. Horizontal mount wiring head.  
Model #'s: SW510840890000 (RTD)  
CT13073C022100 (wiring head with transmitter)
4. Smart (4-20mA with HART) temperature transmitter, field programmable range, no display, with pre-wired RTD, Pharmaceutical Series with 1.5" Tri-Clamp® fitting. Vertical mount wiring head with 25' pre-wired cable.  
Model #'s: SW510040370000 (RTD)  
CT14999P001105 (wiring head with transmitter)

