

Rotary Positive Displacement Pumps

UNIVERSAL LOBE SERIES



Provided by:

Holland[®]
APPLIED TECHNOLOGIES

www.hollandapt.com

Phone: 800-800-8464

For more than half a century, Waukesha Cherry-Burrell has been a leader in the design, manufacturing and application of external circumferential piston, positive displacement pumps.

Users of Waukesha PDs benefit from decades of continuing product improvement. Steady advances in design, metallurgy and fabrication techniques have yielded progressively higher levels of performance and service life.

Most of the pumps that have carried the Waukesha Cherry-Burrell name over this time were designed for heavy-duty pumping challenges..

SPX FLOW, Inc. (NYSE:FLOW) is a leading manufacturer of innovative flow technologies, many of which help define the industry standard in the market segments they serve. From its headquarters in Charlotte, North Carolina, it operates a sales and support network, centers of manufacturing excellence, and advanced engineering facilities, throughout the world. Its cutting-edge flow components and process equipment portfolio includes a wide range of pumps, valves, heat exchangers, mixers, homogenizers, separators, filters, UHT, and drying technology that meet many application needs. Its expert engineering capability also makes it a premium supplier of customized solutions and complete, turn-key packages to meet the most exacting of installation demands.

Incorporating many leading brands, SPX FLOW has a long history of serving the food and beverage, power and energy, and industrial market sectors. Its designs and engineered solutions help customers drive efficiency and productivity, increase quality and reliability, and meet the latest regulatory demands. In-depth understanding of applications and processes, state-of-the-art Innovation Centers, and advanced pilot/testing technology further assist in optimizing processes and reducing timescales to reliably meet production targets.

To learn more about SPX FLOW capabilities, its latest technology innovations and complete service offerings, please visit www.spxflow.com.

The Universal Lobe Pump from Waukesha Cherry-Burrell

HIGH VOLUME, LOWER COST, CIP

The new Universal Lobe Pumps were specifically designed for a different challenge: lower cost and CIP (clean in place) applications.

While intended for lower cost, Universal Lobe Pumps are not "light duty." They incorporate the advanced technology of the new Universal II PD that strengthens sanitary performance and extends pump life. They are capable of accommodating high temperatures and pressures up to 300 psi (20.7 bar).

Universal Lobe Pump Series utilize the Universal II gear case with 3-way mounting flexibility. It offers the full range of seal and port options and has Integral Speed Reducer (ISR) mounting capabilities.

FEATURES AND BENEFITS

Sanitation Features

- CIPable. Pump body has an internal flat profile and is free draining with vertical ports.
- Cover is free draining in horizontal or vertical port positions.
- Rotor/shaft connection sealed from product zone.
- Exclusive, non-galling Waukesha "88" alloy rotors standard; permits running at tighter clearances and higher efficiencies; 316 stainless steel lobe rotors also available.
- Mechanical seals standard. Single or flushed double.
- Seal flush optional: seal areas interconnected to improve circulation and draining of seal flush fluid. Steam-In-Place also is optional.
- Jacketed cover optional.
- 316 stainless steel pump body and cover; 316L optional.
- Electro-polish of product contact surfaces, optional.
- Stainless steel bearing frame optional.

Long-life features

Precision rotor movement virtually eliminates vibration; extends seal life.

- Rotor nut designed for extended service without loosening.
- No bearing in product zone.
- Larger diameter shafts in seal area for greater strength and stiffness.
- Heavy duty bearing frame (stainless steel available as an option)
- Double tapered roller bearings on all models. Contribute further to precise rotor movement and longer seal life.
- Greased lubed bearings for positive lubrication to all bearings over entire speed, temperature and pressure range.
- Body retaining screws for maintaining mechanical seal contact during inspection.

- Extended outer seal life. A wave spring, instead of an o-ring, mechanically loads the seal.
- O-ring on inner seal, seals on clean surface as seal moves due to wear.
- 3 full-radius drive pin grooves reduce stress/increase durability of seals.

Installation flexibility

- Bidirectional flow. Rotors, locked with belleville washers and torqued nuts, rotate securely in either direction. No more flow direction/shaft position specification.
- Interchangeable installation dimensions with Universal and Universal II PD pumps.
- Versatile 3-Way mounting of gear case, including vertical alignment of ports.
- Upper or lower shaft position.



Shown with optional stainless steel gearcase

Typical product applications

Bakery

- Batters
- Flavorings
- Frostings
- Fats & Oils
- Sweeteners
- Yeast
- Slurry



Beverage

- Beer, Wort, Yeast Soft Drinks
- Fruit Drinks
- Juice Concentrate



Canning

- Baby Foods
- Soups
- Fruit Puree
- Puddings
- Jellies
- Salad Dressings
- Mayonnaise

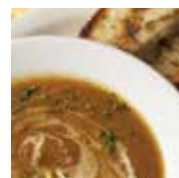

Confectionary

- Syrups
- Cream Fillings
- Chocolate



Dairy

- Cream
- Milk Ice Cream Mix
- Yogurt



Cosmetics

- Face Creams & Lotions
- Hair Styling Gels
- Liquids Essential Oils
- Dyes & Alcohols



Chemical/Industrial

- Solvents
- Fuels
- Oils & Lubricants
- Soaps



Performance and Long Life Through Engineering.

Higher pressure capability, up to 300 psi (20.7) bar.

Longer service life resulting from fresh engineering approach and high capacity components.

The right seal for every application, plus interchangeability when needed.

Metal rotor: exclusive Waukesha 88 non-galling alloy rotors provide close clearance; 316 stainless lobe rotors available.

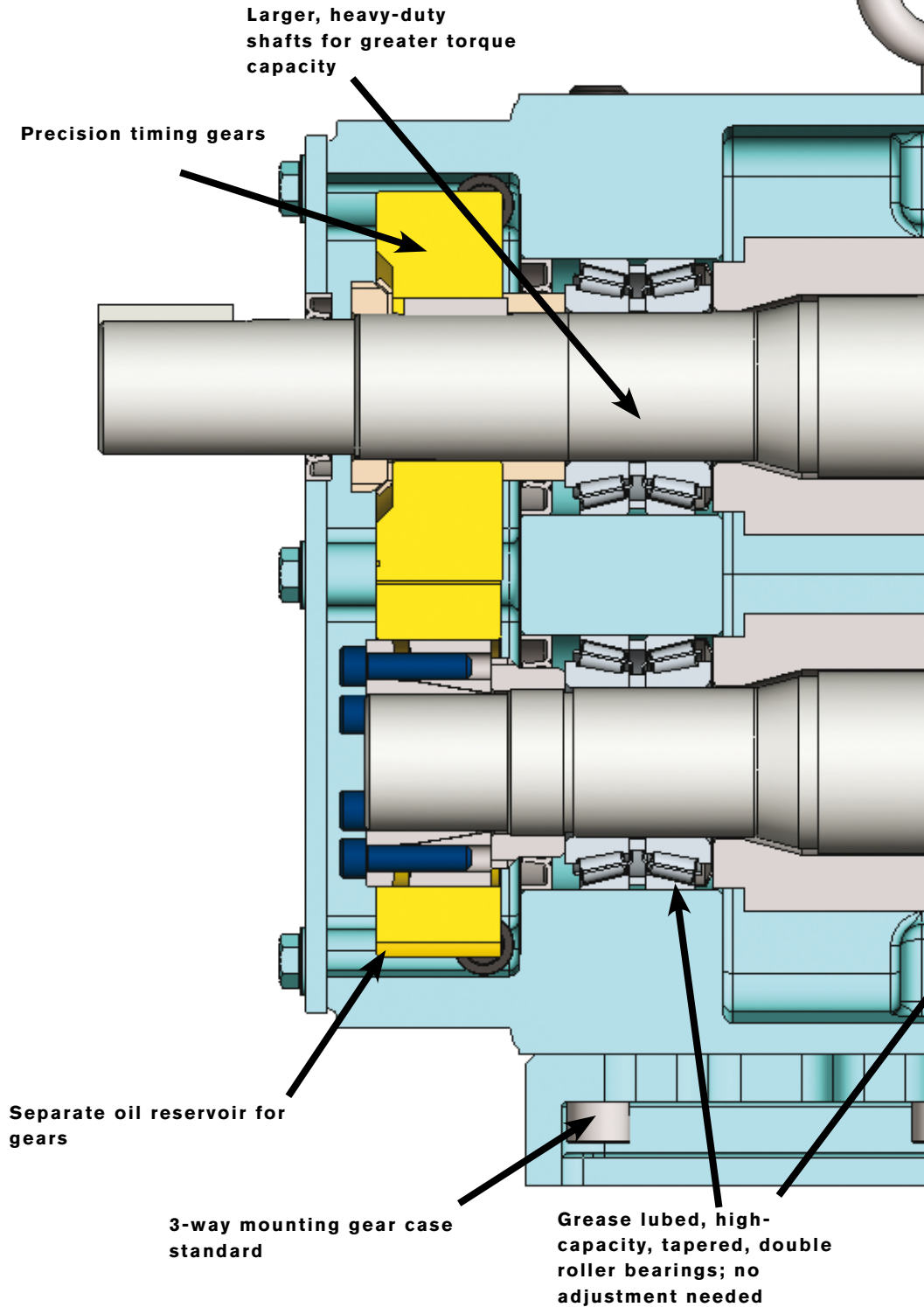

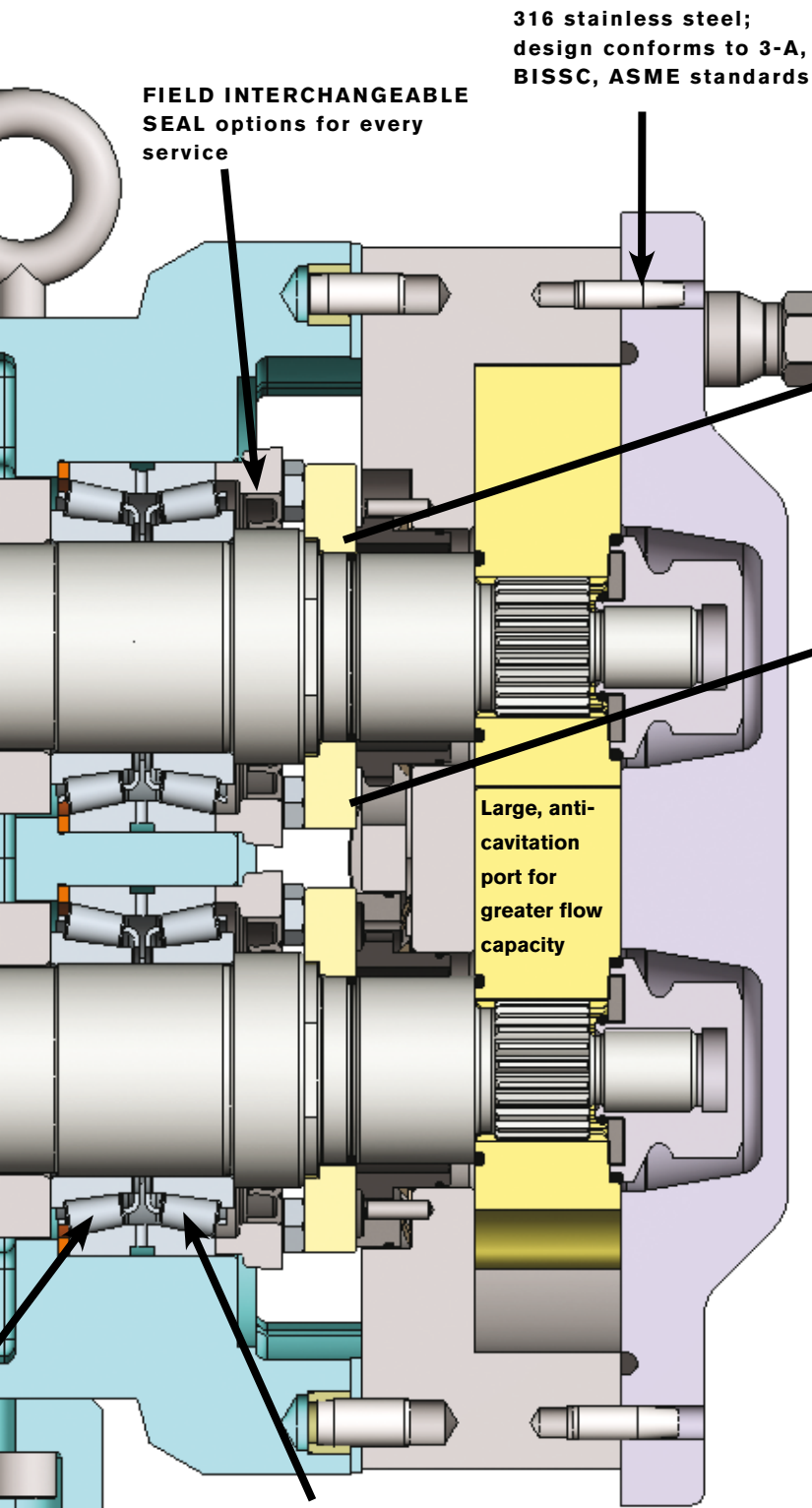

FIELD INTERCHANGEABLE SEAL options for every service

316 stainless steel; design conforms to 3-A, BISSC, ASME standards

Large, anti-cavitation port for greater flow capacity

Front bearing fixed; rear bearing floating. Better control of thermal expansion when handling hot products

SEAL OPTIONS

Double Concentric Mechanical Seal*

Used with flushing fluid to cool, lubricate, flush away residue. Best arrangement for severe service.

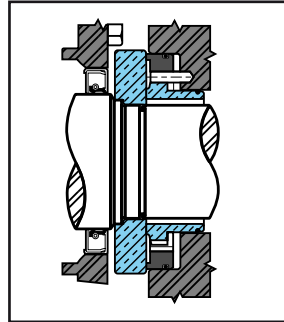

Single Mechanical Seal*

Longer life, wider pressure-temperature-speed range. Carbon-to-ceramic faces standard. Alternate materials available for abrasive service.

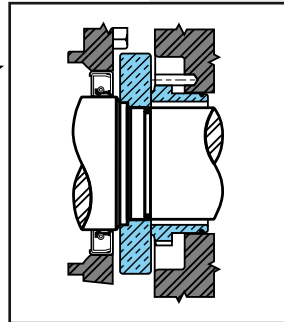

Elastomer choices for “O” rings:

- Buna-N
- Fluoroelastomer (FKM)
- EPDM
- Silicone
- Perfluoroelastomer (FFKM)
- PTFE Encapsulated

***Mechanical seal material options:**

- Carbon
- Ceramic
- Silicon Carbide
- Tungsten Carbide

PRODUCT DIMENSIONS

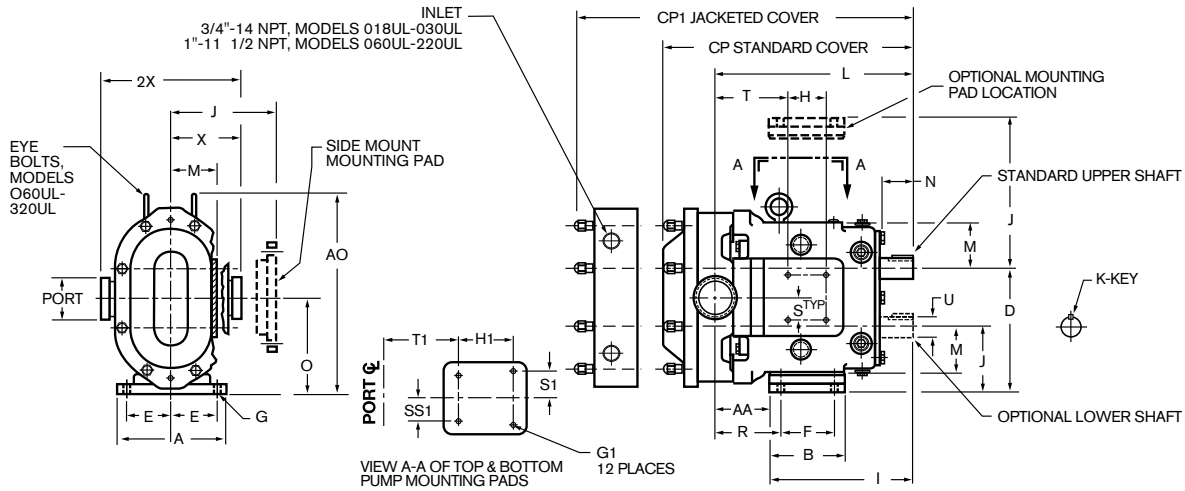

MODEL	DIM.	A	AA	AO	B	CP	CP1*	D	E	F	G	G1	H	H1	I	J
018-UL	IN	4.75	2.82	8.30	3.75	12.37	14.53	5.50	1.94	2.31	.41, SLOT	5/16-18 x .62	2.50	2.50	7.66	2.93
	mm	121	72	211	95	314	369	140	49	59	10, SLOT	-	64	64	194	74
030-UL	IN	6.25	2.78	10.29	4.25	14.49	16.43	6.86	2.31	2.56	.41, SLOT	3/8-16 x .62	1.81	2.75	8.83	3.56
	mm	159	71	261	108	368	417	174	59	65	10, SLOT	-	46	70	224	90
060-UL	IN	8.25	4.14	15.31	5.87	18.26	21.00	9.56	3.50	4.12	.53	1-2-13 x .88	3.00	4.13	10.99	5.06
	mm	210	105	389	149	464	533	243	89	105	.13	-	76	105	279	129
130-UL	IN	8.25	4.78	15.31	5.87	19.28	22.02	9.56	3.50	4.12	.53	1/2-13x.88	3.00	4.13	10.99	5.06
	mm	210	121	389	149	490	559	243	89	105	13	-	76	105	279	129
220-UL	IN	8.50	3.69	19.13	9.00	23.07	25.81	12.38	3.75	7.25	.53, SLOT	1/2-13x1.00	5.38	5.38	14.80	6.38
	mm	216	94	486	229	586	655	314	95	184	13, SLOT	-	137	137	376	162
320-UL	IN	12.00	4.12	22.38	11.63	26.65	NA	13.88	5.25	8.00	.66	1/2-13x1.00	5.38	5.38	17.80	6.88
	mm	305	105	568	295	677	NA	353	133	203	17	-	137	137	452	175

MODEL	DIM.	K	L	M	N	O	PORT	R	S	S1	SS1	T	T1	U +0.000 -0.01	X**	2X**
018-UL	IN	.19	10.48	2.12	2.00	4.21	1-1/2"	3.66	1.00	1.00	1.00	3.38	2.51	.875	3.49	6.97
	mm	5	266	54	51	107	-	93	25	25	25	86	64	22.23	89	177
030-UL	IN	.25	11.61	2.62	2.32	5.21	1-1/2"	3.84	1.12	1.12	1.12	4.00	3.59	1.250	4.25	8.50
	mm	6	295	67	59	132	-	98	28	28	28	102	91	31.75	108	216
060-UL	IN	.38	15.14	3.50	2.25	7.31	2-1/2"	5.01	1.75	2.00	1.75	5.62	5.01	1.625	5.37	10.75
	mm	10	385	89	57	186	-	127	44	51	44	143	127	41.28	136	273
130-UL	IN	.38	15.77	3.50	2.25	7.31	3"	5.65	1.75	2.00	1.75	6.25	5.66	1.625	5.37	10.75
	mm	10	401	89	57	186	-	144	44	51	44	159	144	41.28	136	273
220-UL	IN	.50	18.49	4.50	2.75	9.38	4"	4.44	2.69	2.69	2.69	6.00	6.00	2.000	6.63	13.25
	mm	13	470	114	70	238	-	113	68	68	68	152	152	50.80	168	337
320-UL	IN	.63	21.65	5.06	4.06	10.38	6" 150# FLANGE	5.09	2.69	2.69	2.69	8.37	8.37	2.375	8.00	16.00
	mm	16	550	129	103	264	-	129	68	68	68	213	213	60.45	203	406

*NOTE: CP1 will not apply to Model 320.

**NOTE: Dimensions "X" and "2X" apply for Bevel Seat, "S"-Clamp, "Q"-Clamp, 151 and 141 fittings on Models 018 through 220. Standard port is Bevel Seat.

Dimensions "X" and "2X" apply for 6" (152 mm) 150 lb. RF Flange on Model 320.

PRODUCT SPECIFICATIONS

MODEL	DISPLACEMENT PER REVOLUTION	NORMAL CAPACITY TO*	INLET/OUTLET	PRESSURE RANGE UP TO**	MAXIMUM RPM	TEMP. RANGE**
018-UL	.033 gal (.12 L)	33 gal/min (7.5 m³/h)	1 1/2" (38 mm)	200 psi (13.8 bar)	1000	-40° F/C to 300° F (149° C)
030-UL	.071 gal (.27 L)	70 gal/min (15.9 m³/h)	1 1/2" (38 mm)	300 psi (20.7 bar)	1000	
060-UL	.153 gal (.58 L)	120 gal/min (27.2 m³/h)	2 1/2" (64 mm)	300 psi (20.7 bar)	800	
130-UL	.253 gal (.96 L)	175 gal/min (39.7 m³/h)	3" (76 mm)	200 psi (13.8 bar)	700	
220-UL	.502 gal (1.90 L)	300 gal/min (68.1 m³/h)	4" (102 mm)	200 psi (13.8 bar)	600	
320-UL	.878 gal (3.32 L)	525 gal/min (119.2 m³/h)	6" (152 mm)	200 psi (13.8 bar)	600	

OPTIONS AND ACCESSORIES

Ports

Male NPT and 150 lb. flanges optional on Models 018 through 220 size. 150 lb. RF flanges standard on Model 320.

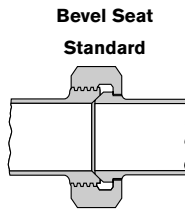

Bevel Seat
Standard

Optional Sanitary Clamp Type Variety of styles including S-Line, I-Line, Q-Line

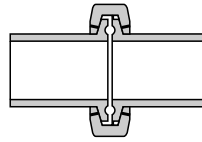

Optional European Types; DIN, SMS, RJT

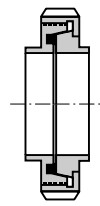

Rotors

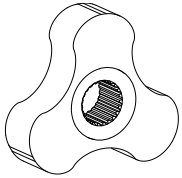

Alloy 88 Standard. 316SS Optional.

Rotor clearance standard for most applications up to 200°F (93°C).

Hot clearance rotor option for applications up to 300°F (149°C).

Contact application engineering for higher temperature applications.

O-rings

Elastomer choices for "O" rings:

Standard

- Buna-N

Optional

- Viton
- EPDM
- Silicone
- Kalrez/PTFE Encapsulates

Cover & Gearcase

Optional drain and/or vent connections

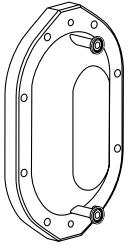

Shown with optional 3-wing cover nuts



Seals

Mechanical seal material options:

- Carbon
- Ceramic
- Silicon Carbide
- Tungsten Carbide

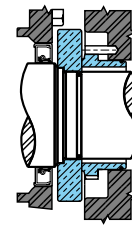

Single Mechanical Seal

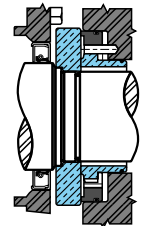

Double Concentric Mechanical Seal

Shaft Position

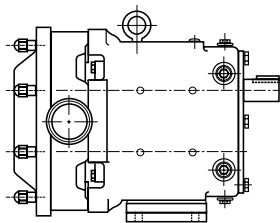

Top Shaft Position
Standard

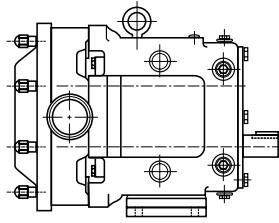

Lower Shaft Position
Optional

Mounting

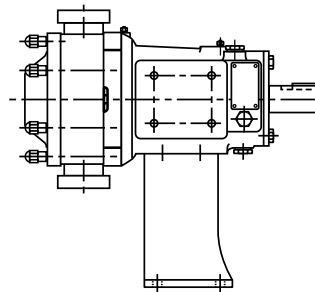

Optional Side Mount Gear Case for vertical fluid entry and free draining of body

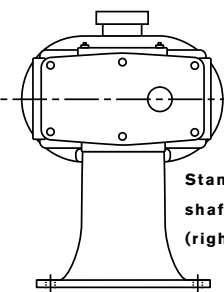

Standard left hand shaft position shown (right hand optional)

Bases & Drives

- Plate with adjustable feet or Channel Bases
- 304 SS Plate Bases
- Portable Bases with Rubber Wheels
- Direct connected Gear Motors
- Mechanical and Electronic Variable Speed Drives
- Hydraulic Motor Drives

Rotary Positive
Displacement
Pumps

UNIVERSAL LOBE SERIES

SPXFLOW

Provided by:



Based in Charlotte, North Carolina, SPX FLOW, Inc. (NYSE: FLOW) is a multi-industry manufacturing leader. For more information, please visit www.spxflow.com

SPX FLOW

611 Sugar Creek Road

Delavan, WI 53115

P: (262) 728-1900 or (800) 252-5200

F: (262) 728-4904 or (800) 252-5012

E: wcb@spxflow.com

SPX FLOW, Inc. reserves the right to incorporate our latest design and material changes without notice or obligation.

Design features, materials of construction and dimensional data, as described in this bulletin, are provided for your information only and should not be relied upon unless confirmed in writing. Please contact your local sales representative for product availability in your region. For more information visit www.spxflow.com.

The green "y" and "x" are trademarks of SPX FLOW, Inc.

ISSUED 07/2016 FH-1733

COPYRIGHT © 2016 SPX FLOW, Inc.