

DISTRIBUTED BY:

Holland
APPLIED TECHNOLOGIES

www.hollandapt.com
630-325-5130

SOLVING NANOTECHNOLOGY APPLICATION CHALLENGES

Industry-leading Microfluidizer® processor
technology for optimum performance
and superior product quality



MICROFLUIDICS

SOLVING NANOTECHNOLOGY APPLICATION CHALLENGES

Superior Technology

Microfluidizer® processor technology leads the industry with higher yields of active ingredients and greater control over process repeatability.

Superior Results

Unrivalled results in uniform nanoemulsions, cell disruption and uniform particle size reduction, as well as seamless scale-up and unparalleled repeatability.

No other high-pressure processor is capable of generating the shear levels achieved by Microfluidizer® processor technology.

Microfluidics' equipment consistently achieves significant particle size reductions, and uniform particle size distributions.

If dependant upon nanotechnology for innovative products with properties and advantages that are superior to the competition, count on Microfluidics for high-pressure processors that are leading the global nano-revolution.

The Microfluidics Difference

Microfluidizer® processors ensure that every mL of material gets the same high-shear treatment regardless of whether you are processing a 1 mL batch or thousands of liters per hour.

Applications

Microfluidizer® processors deliver for challenging applications that require the smallest possible particle size and narrow / uniform distribution.

Learn more, page 4.

Products

Precision-manufactured Microfluidizer® processor technology helps set performance standards for high-pressure processing success throughout the industry.

Learn more, page 10.

Industries

Microfluidizer® high-shear fluid processors are vital to the development and production of a broad range of products across diverse industries.

Learn more, page 12.

The exclusive producer of Microfluidizer® high-shear processors.

Microfluidizer® processor technology is often used for **emulsification** (dispersion of one liquid phase into another liquid phase) and **deagglomeration** (dispersion of a solid into a liquid).



MICROFLUIDIZER® PROCESSORS

UNPARALLELED PERFORMANCE ACROSS MULTIPLE APPLICATIONS

Microfluidics has both the knowledge and experience to help customers create superior products and improve processing efficiency for a wide range of applications. Upon determining product goals, the Microfluidics team works with you to develop the best solution – utilizing the appropriate equipment and optimal processing parameters – for each unique formulation.

Microfluidizer® high-shear fluid processors are capable of achieving unparalleled, consistent, dependable and scalable results in the areas of nanoemulsions, cell rupture, liposomes, submicron particle size reduction, and deagglomeration. Microfluidics' high-pressure processors are used extensively by leading companies in the pharmaceutical, biotechnology, chemical, energy, cosmetic and food-nutraceutical industries.

Microfluidizer® processors offer superior results over conventional equipment in terms of greater particle size reduction, tighter particle size distribution, repeatability and seamless scalability.

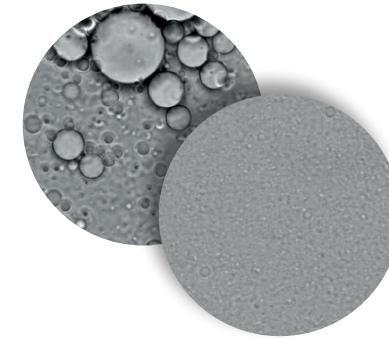

Nanoemulsions that can be sterile filtered

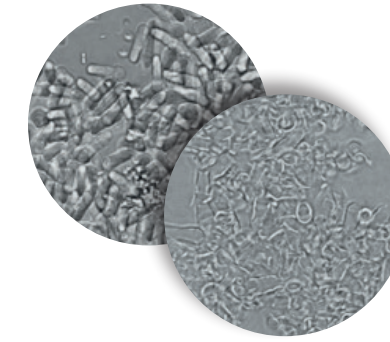

Cell disruption with highest levels of protein recovery

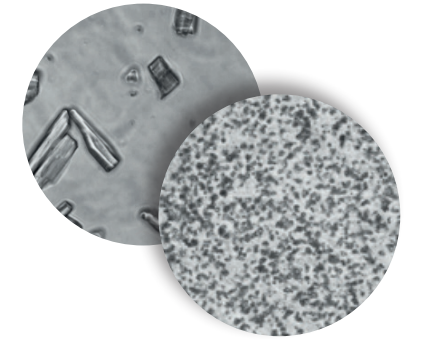

Uniform particle size reduction

Industry Acknowledged

The combined performance and scalability of Microfluidizer® processors means they excel at the following applications:



Nanoemulsions

Microfluidizer® processor technology produces superior nanoemulsions with extremely small droplet sizes and narrow distributions.



Cell Disruption

Break cells with high-efficiency while maintaining intracellular content integrity allowing for the easiest downstream purification.



Polymer Nanoparticles

The ideal technology for producing small sterile, filterable polymer nanoparticles using Microfluidizer® processors.



Polysaccharides

Reduce the molecular weight of polysaccharides with minimal altering of the chemical structure.



Particle Size Reduction

Microfluidizer® high-shear fluid processors stand alone in their ability to achieve uniform size reduction results.



Nanoencapsulation

Microfluidizer® processor technology for high-efficiency nanoencapsulation applications can produce competitive differentiation in products and processes.



Liposomes

Microfluidizer® processor technology successfully processes liposomes and offers an ideal solution for the production of liposomal formulations.

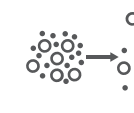

Deagglomeration

Whether an application requires deagglomeration, dispersion, delamination, exfoliation or defibrillation, Microfluidizer® processors provide an efficient solution.

SUPERIOR TECHNOLOGY DELIVERING UNRIVALLED RESULTS

How It Works

Product enters the system via the inlet reservoir and is pulled into a constant pressure pumping system which pushes the material through a fixed geometry Interaction Chamber™ with pressures of up to 30,000 psi (2068 bar) where it experiences consistent, high-shear rates and impact forces.



Highest Shear Rates for Smallest Particles

Microfluidizer® processors consistently generate significantly higher shear rates than other methods.

By precisely controlling the level of shear applied, customers are able to process shear-sensitive materials and high-pressure applications. More efficient reduction of particles to the nano level allows customers to use less energy to achieve particle size results that are, on average, half the size of even the most effective processor outputs.

Uniform Particle Size Distribution

Creating tiny particles is one step. A crucial second factor, often overlooked by manufacturers of other particle size reduction equipment, is generating a uniform particle size distribution in the process.

This is where Microfluidizer® processor technology has proven its value in thousands of customer applications over the years; producing the most narrow particle size distribution results possible. Naturally, this yields greater stability, longer shelf life, more efficient use of raw materials, and significant potential savings in the filtration process.

1

The sample is first poured into the inlet reservoir.

2

The Microfluidizer® processor constant pressure pumping system forces the material through the Interaction Chamber™. Operating pressures of up to 30,000 psi.

3

Fluids inside the Interaction Chamber™ (a very small micro-channel) can travel at velocities of up to 500 m/s. All material receives consistent, high-shear rates and impact forces.

4

Finally, the finished product passes through the cooling coil to control temperature, and is collected.

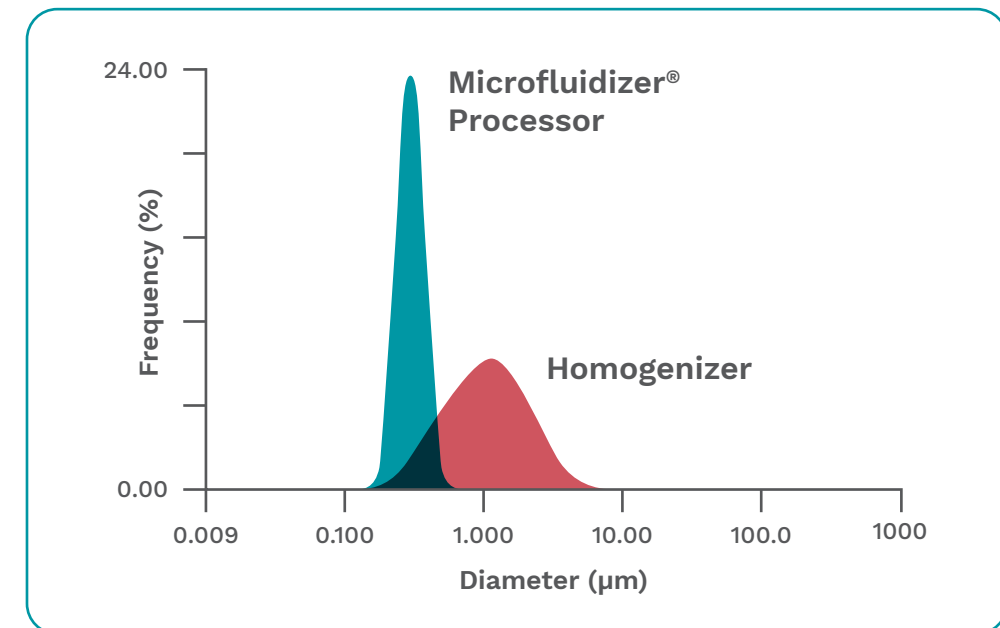
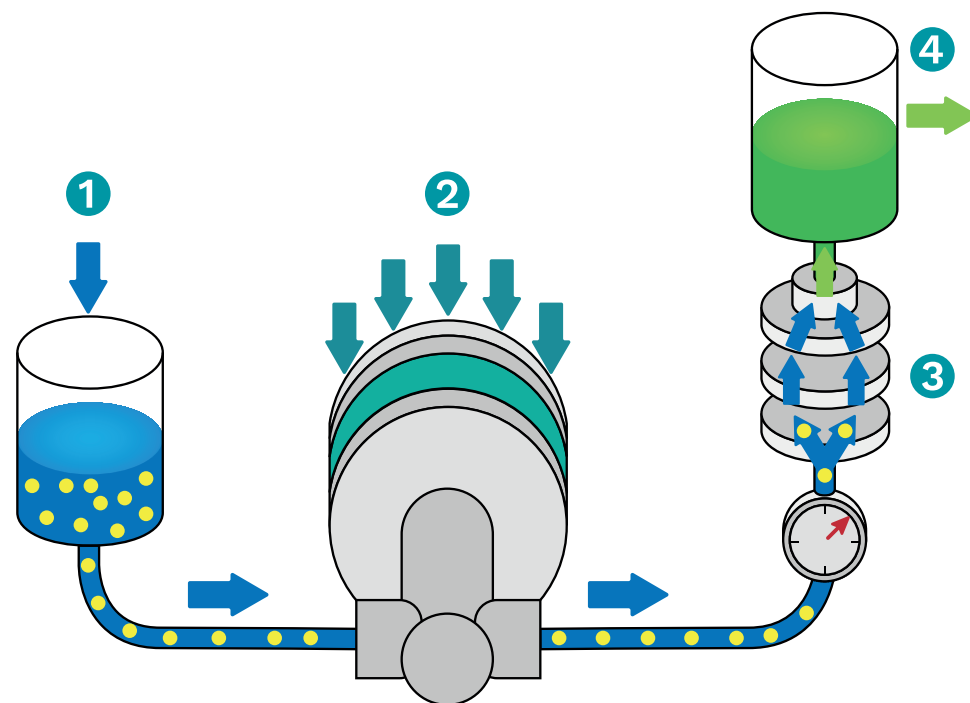

MICROFLUIDICS IS THE WORLD'S PREMIER PROVIDER OF BIOTECH AND PHARMACEUTICAL HIGH-SHEAR PROCESSING EQUIPMENT

SCALABLE SUCCESS FROM LABORATORY THROUGH TO PILOT TO PRODUCTION

Achieving success in the lab is valuable only if it can be repeated reliably, regardless of scale. Microfluidics further differentiates from other technologies in that not only are results repeatable from batch-to-batch, but also from lab environments to pilot and production volumes.

Lab & Benchtop

Microfluidizer® high-pressure lab processors



Pilot-Scale

Reduce the time to market with linear scale-up



Production-Scale

Achieve superior, scalable results in production environments



MICROFLUIDIZER® PROCESSORS ENSURE THAT EVERY mL OF MATERIAL GETS THE SAME HIGH-SHEAR TREATMENT REGARDLESS OF WHETHER YOU ARE PROCESSING A 1 mL BATCH OR THOUSANDS OF LITERS PER HOUR

Microfluidics' scalable, fixed geometry Interaction Chamber™

The heart of the Microfluidizer® processor, the Interaction Chamber™, utilizes fixed geometry designs and scales up linearly with parallel aligned micro-channels. This ensures that the entire product stream experiences identical shear, resulting in consistent quality no matter the volume: from 1 mL (with the LV1 low volume lab machine) up to 60 liters per minute.

Our Y-Chambers are recommended for liquid-to-liquid dispersion processes:

- Emulsions
- Encapsulation
- Liposomes
- Polymer Particles

Our Z-Chambers are recommended for suspension of a solid into a liquid:

- Particle Size Reduction
- Dispersion
- Cell Disruption
- Deagglomeration



Y-CHAMBER

Z-CHAMBER

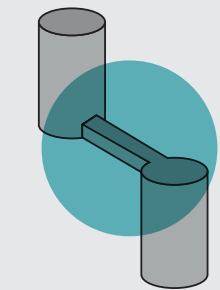
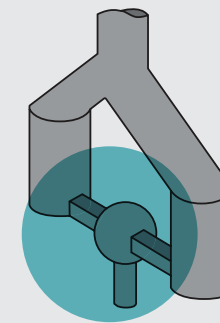

FROM LABORATORY...

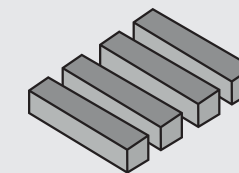

...TO PRODUCTION

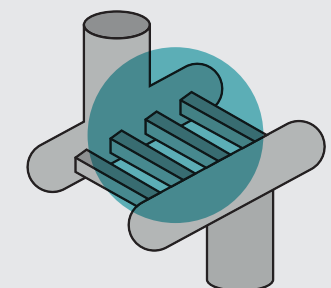
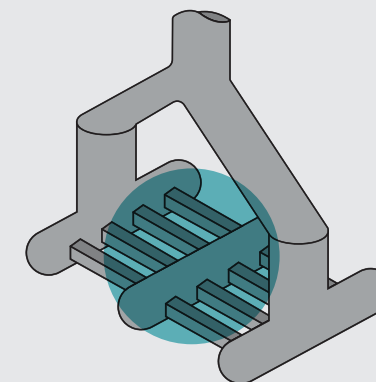

A PRODUCT RANGE DESIGNED FOR PRECISION AND PERFORMANCE

Microfluidizer® processor technology more efficiently converts high-pressure into shear forces, helping to set performance standards for high-pressure processing success throughout the industry.

Microfluidics' models differ only in their characteristic batch size / flow rates, pressure ranges and motor types. Microfluidics offer a range of processors, from benchtop laboratory models capable of processing small, investigatory samples, to pilot and production-scale machines capable of handling progressively larger batch sizes.

The core of our technology ensures that all processing conditions from pressure, Interaction Chambers™ and number of passes remain the same from lab-scale to production-scale processing.

cGMP Compliant
Microfluidics' biopharma equipment is used in more biopharma productions globally – including in the production of many FDA-approved drugs – than any competitive products. Microfluidics is a best-in-class manufacturer, having more than 20 years of experience with cGMP requirements for pharmaceutical applications. Count on in-depth professional knowledge, expert support, and high-capacity biopharmaceutical manufacturing equipment.



Lab & Benchtop Equipment

This is the equipment designed for lab-scale processing – from R&D to small-scale batches. If looking for a benchtop model, Microfluidics' laboratory processors offer the consistency, scalability and efficiency needed from small-scale processing equipment.



LM10
Digitally controlled pneumatic lab unit for small sample material processing



LM20
Digitally controlled electric powered lab unit for small sample processing



M110P **cGMP Compliant**
The flagship plug & play laboratory unit with cGMP-compliance capability

Pilot-Scale Equipment

High-pressure processors designed to bring you one step closer to going to market. The M110EH pilot-scale unit is the bridge between R&D and production. Before scale-up to full production-scale processing, you need a cost-effective solution for pilot batch production.



M110EH **cGMP Compliant**
Available in basic, enhanced and aseptic biopharma models for various applications



M815 **cGMP Compliant**
For processing pilot-scale and small production batches

Production-Scale Equipment

Microfluidics' production-grade industrial processors are the equipment of choice for scale-up in pharmaceutical, biotech, chemical, cosmetic and food-nutraceutical processing applications. Offering scalable, repeatable results, the M700 series is the proven choice for cost-effective industrial processing equipment that stands up to a high-demand production environment.



M700 **cGMP Compliant**
Customizable M700 Series Microfluidizer® processors for robust manufacturing of production batches

UNIQUE TECHNOLOGY ENABLING INDUSTRY TO INNOVATE

Microfluidizer® high-shear fluid processors are vital to the development and production of a broad range of products across diverse industries.

Microfluidics' unique technology is set apart from traditional industrial homogenizers and valve processors. For challenging applications that require the smallest possible particle size and remarkably uniform particle size distribution, only an extraordinary Microfluidizer® processor will do.

Providing premium equipment to support drug development and manufacturing for pharmaceutical formulations.

Virtually all of the top 20 pharmaceutical companies rely on Microfluidizer® processor technology as the undisputed gold standard for uniform particle size reduction for nanoemulsions, dispersions, nanoencapsulation and cell disruption.

For biotech companies worldwide, successful cell disruption begins with Microfluidizer® processing equipment.

Microfluidics high-shear cell disruption, or cell lysis, with improved protein recovery and guaranteed scale-up capabilities are driving the biotech industry.

The flexible, robust Microfluidizer® processors provide better processing results than can be attained from other cell disruption methods or technologies. Microfluidics high-pressure processors are used to rupture a wide variety of cells with specific shear requirements.

Microfluidizer® technology offers scalable vaccine production from R&D in the lab to full-scale manufacturing in the factory. Proven to produce stable nanoemulsion adjuvants that are successfully sterile filtered. Lipid nanoparticles (LNPs) can be produced in high volumes with consistent results.

Proven process efficiency

From start-ups to contract manufacturers to global pharma, nearly two-thirds of the Microfluidizer® processors installed worldwide are used for biopharmaceutical applications. By reducing particle size uniformly, Microfluidics help pharma leaders improve the quality, bioavailability, stability and process efficiency of their drugs.



“I highly value the Microfluidizer® Machine for cell disruption. It's very reliable, processing hundreds of liters of our diverse cell suspensions with very few problems. My colleagues and I have used two different brands of competitive equipment, but now have switched exclusively to Microfluidics. The difference is night and day. Yields of usually difficult, otherwise poorly soluble proteins are much higher after disruption with the Microfluidizer® processor. Overall, I am very happy that I switched to the LM20 Microfluidizer® processor.”

Prof. Thomas Schwartz
Massachusetts Institute
of Technology (MIT) (USA)

Diverse industries have embraced Microfluidizer® processor technology for the creation of products with qualities that are only possible using nano-scale materials.

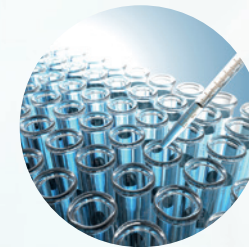

Pharmaceutical

Providing premium equipment to support drug development and manufacturing for pharmaceutical formulation



Biotechnology

Helping global biotech companies meet diverse and demanding needs for cell rupture



Vaccines

Microfluidizer® processors are developed to support vaccine adjuvant production and protein antigen recovery



Chemical / Industrial

Improving the function of many materials with particle size reduction in high-performance materials



Energy

Developing cutting-edge innovations in energy products with nanotechnology for applications and solutions



Cosmetic

Helping cosmetic companies improve product quality and stability for an unprecedented level of control



Food / Nutraceutical

Enhanced nanoencapsulation of nutrition ingredients, flavor and color



Cannabis

Microfluidizer® processor technology for next generation cannabis products for pharmaceutical formulation

PARTS, ACCESSORIES & SERVICE

SUPPLYING ONLY GENUINE OEM PARTS

Microfluidics' machines and components meet the highest specifications for quality and reliability. Microfluidics only supply OEM genuine parts from the factory, which have been tested and inspected to meet the highest quality standards.

When replacement parts are needed for Microfluidics' equipment, the Aftermarket Team is always standing by to fulfill any requirements.

Spares

Microfluidics are always developing new and improved versions of existing components as customers challenge us with new and exciting applications.

Technical Support

With Preventive Maintenance, expert field service engineers arrive at a customer's facility to identify and resolve potential performance issues before they arise. Microfluidics also train customer staff members to improve their internal knowledge base and skill set. This enables them to plan their maintenance schedule and ensures the processor always operates at its optimal capacity when needed.

Customer Service

Trained personnel are always available to help solve problems quickly and effectively, and to keep downtime to a minimum.

Their mission is to minimize or eliminate downtime while maximizing process efficiency for customers through quick, convenient and reliable service offerings, genuine spare parts and proactive personal follow-ups.



“Digital controls allow the system pressure to be set more easily and accurately compared to alternative manual processors, reducing the potential for errors and increasing reproducibility. The in-depth user training, and easy operation and maintenance procedures have been extremely beneficial. I feel confident to troubleshoot and perform preventative maintenance without having to call the support teams - it doesn't feel like a 'black box' machine. I would recommend the LM20 Microfluidizer® as an essential tool for cell disruption.”

James Wright
Protein Scientist – Abcam Plc, UK

“Maintenance requirements are much lower now. With the competitive systems, maintenance was a constant problem and required several service visits per year. Overall, I am very happy that I switched to the LM20 Microfluidizer® processor.”



INNOVATIVE PRODUCTS BACKED BY WORLD-LEADING EXPERTISE AND SUPPORT

DISTRIBUTED BY:



www.hollandapt.com
630-325-5130



Microfluidizer® processor technology produces unrivaled results in uniform nanoemulsions, cell disruption and uniform particle size reduction, seamless scale-up and unparalleled repeatability.

Process engineers in industries as distinct as pharmaceutical, fine chemical, biotechnology, cosmetic, food processing and energy have discovered that Microfluidics represents superior processing technology.

Discover and experience the Microfluidics' difference!

● Headquarters

● IDEX MPT Centers of Excellence

Representation in over 80 countries worldwide

IDEX Material Processing Technologies



High-Pressure
Fluid Processing



Dry Granulation
Hammer Milling



Lean Powder Handling
Batching, Mixing & Packing



Conical Milling
High-Shear Mixing

Microfluidics International Corporation

90 Glacier Drive, Suite 1000
Westwood, MA 02090

Tel: +1.617.969.5452

Email: mixinginfo@idexcorp.com | www.microfluidics-mpt.com